

Use of glass and acrylic glass in stand construction and design inside trade fair halls

This information sheet has been jointly agreed upon by

Deutsche Messe AG Hannover

KölnMesse GmbH

Leipziger Messe GmbH

Messe Berlin GmbH

Messe Düsseldorf GmbH

Messe Frankfurt Venue GmbH

Messe München GmbH

NürnbergMesse GmbH

Messe Friedrichshafen GmbH takes over the following implementation of mentioned above Exhibition organisers.

December 1st 2012

| CONTENTS | Page |
|--|--------------|
| 1 SCOPE OF APPLICABILITY..... | 3 |
| 2 DEFINITIONS AND EXPLANATIONS..... | 3 |
| 2.1 Types of supports..... | 3 |
| 2.2 Types of glass and acrylic glass..... | 3 |
| 2.3 Design calculation standards..... | 4 |
| 2.4 Material properties of glass products..... | 5 |
| 3 STAND DESIGN, CONSTRUCTION AND LOADS | 5 |
| 3.1 Vertical glazing not intended to prevent falling | 5 |
| 3.1.1 Vertical glazing of a height $h \leq 4$ metres above hall floor level | 5 |
| 3.1.2 Vertical glazing of height $h > 4$ metres above hall floor level | 5 |
| 3.2 Vertical glazing intended to prevent falls | 6 |
| 3.2.1 Category A – vertical glass wall | 6 |
| 3.2.2 Category B – clamped glass balustrade with continuous handrail..... | 6 |
| 3.2.3 Category C – Railing and balustrade infills and glass walls with load-distributing cross-bar fitted in front of it..... | 7 |
| 3.3 Horizontal glazing | 7 |
| 3.3.1 Overhead glazing | 7 |
| 3.3.2 Glazing designed to support human loads..... | 8 |
| 4 APPROVAL PROCEDURES | 8 |
| 4.1 Basics..... | 8 |
| 4.2 Installation approval for a specific case..... | 9 |
| 5 NOTES ON DESIGN AND DESIGN CALCULATIONS | 10 |
| 6 EXAMPLES OF STRUCTURES (BARRIERS) DESIGNED TO PREVENT FALLS..... | 10 |
| 6.1 Category B..... | 10 |
| 6.2 Category C1..... | 11 |
| 6.2.1 Railing infills secured vertically on 2 sides | 11 |
| 6.2.2 Railing infills secured horizontally on 2 edges | 11 |
| 6.2.3 Railing infills secured on 4 sides | 11 |
| 6.2.4 Glazing secured at individual points by means of drilled anchorage points (design specifications in accordance with TRAV and/or DIN 18008-4) | 12 |
| 6.2.5 Point mounting with lateral clamps and anti-slip grips | 13 |
| 6.2.6 Point mounting with clamps at top and bottom | 13 |
| 6.3 Balustrade with horizontal bars (protection against falling is provided solely by sufficiently strong handrails and knee-height bars) | 13 |
| 7 CONSTRUCTION ENGINEERING REGULATIONS, GENERALLY ACCEPTED RULES OF ENGINEERING AND REFERENCES | 14 |
| 8 ABBREVIATIONS | 15 |
| 9 KEYWORD INDEX | 16 |
| 10 TABLES CONTAINING-INFORMATION FOR STAND BUILDERS | 18-20 |

1 SCOPE OF APPLICABILITY

This information sheet discusses the regulations concerning the use of glass and acrylic glass in stand construction and design inside trade fair halls. It does not apply to stand construction and design outside trade fair halls.

Designing, dimension calculations and assembly of glass components for use inside trade fair halls require that the design, planning and assembly personnel involved is adequately qualified for glass construction projects.

Glass structures which have received general construction approval (including European Technical Approval ETA) may be used in all cases in trade fair halls in accordance with the wording of the approval. This information sheet does not impose restrictions on the use of such structures.

2 DEFINITIONS AND EXPLANATIONS

2.1 Types of supports

- Glazing secured by linear supports:
secured by linear supports on at least two opposite edges over the full length of each edge of the glass plate.
- Glazing secured at individual points:
glazing anchored through drilled holes or by a clamping system.

2.2 Types of glass and acrylic glass

Types of glass granted statutory construction approval in Building Regulation List A:

- **Float glass** (polished plate glass – PPG) as specified in DIN EN 572-2:
Also called flat or plate glass. It is characterised by relatively low ultimate flexural strength, and when destroyed, it fragments into large sharp-edged shards. Its use as single sheet glazing in trade fair construction is prohibited. If used in LSG, it is permitted in trade-fair construction.
- **Tempered safety glass (TSG)** as specified in DIN 12150-1:
TSG is a fully thermally pre-stressed type of glass. It has internal residual stress characteristics: core tensile stress and surface compression stress. It has high ultimate flexural strength and when broken, it shatters into crumb-like fragments. Where TSG is referred to in this information sheet, TSG made of float glass is always meant.
- **Laminated safety glass (LSG):**
LSG consists of at least two sheets of PPG, TSG or HSG glass. The individual thicknesses of these are not permitted to differ from each other by a factor of more than 1.5. The sheets of glass are laminated together by intermediate film layers (PVB or SGP films). If a sheet is broken, then the film prevents the fragments from being scattered, thus providing residual load-bearing capacities and reducing the risk of injury from cuts.
- **Heat-strengthened glass (HSG)** as specified in DIN EN 1863-1 or with other general approvals by building authorities (German: *allgemeine bauaufsichtliche Zulassung – abZ*):
HSG is a type of glass that is only partially thermally pre-stressed. Its ultimate flexural strength is lower than that of TSG (tempered safety glass). When broken, HSG fragments into shards which are larger than those of broken TSG. Therefore LSG sheets made of HSG have higher residual load-bearing capacities than LSG sheets made of TSG. HSG laminated with PVB film is included in Building Regulation List A. A general construction approval by building authorities (German *allgemeine bauaufsichtliche Zulassung – abZ*) for the SGP film is required for HSG laminated with SGP.

Types of glass for which no statutory construction approval has been granted:

- Acrylic glass:
Acrylic glass is a transparent thermoplastic product marketed under the brand names *Plexiglas®* and *Perspex®*, for example. At present no recognised technical regulations are available for the use of acrylic glass.
- Polycarbonate products: e.g. *Makrolon*

Acrylic glass and polycarbonate may only be used for non-load-bearing, decorative infill components.

2.3 Design calculation standards

The static strength proof calculations for glass components can be carried out in accordance with the following design calculation concepts and structural design standards:

| Design concept | A: comprehensive safety concept | B: load factor concept |
|--|--|---|
| Proof concept | $\sigma < \text{allow. } \sigma$ | $\alpha_k \cdot \gamma_f < f_k \cdot k_c \cdot k_{mod} / \gamma_M$ |
| Determination of action effects and stresses | at SLS (GZG) ^{*)} | at ULS (GZT) ^{*)} |
| Deformation checks | at SLS (GZG) | at SLS (GZG) |
| Designation of forces /stresses in the serviceability limit state SLS (forces due to characteristic loads, without γ_f) | no designation SLS (GZG) | SLS (GZG) after the number or index k after formula symbol e. g. supporting force = 12 kN (SLS) or $F_k = 12$ kN |
| Designation of forces /stresses in the ultimate limit state ULS (forces due to characteristic loads, multiplied by γ_f) | | ULS (GZT) after the number or index d after formula symbol e. g. supporting force = 16 kN (ULS) or $F_d = 16$ kN |
| Designation of the allowable material stress | allow. σ or allowable σ (zul. σ or zulässig σ) | |
| Designation of the limit stress | | f_k |
| Dimension calculation rules, dimension calculation standards | TRLV [5] TRAV [6] TRPV [17] | DIN 18008-1 [12] DIN 18008-2 [13] DIN 18008-3 [14] DIN 18008-4 [15] DIN 18008-5 [16] |
| Standards applying to loads and actions | this information sheet and DIN EN 1991-1-1 DIN EN 1991-1-1/NA: (2010-12) | this information sheet and DIN EN 1991-1-1 DIN EN 1991-1-1/NA: (2010-12) |
| Normal load factors γ_f for permanent loads (e. g. dead loads) | | 1.35 |
| Normal load factors for variable loads and actions (e. g. dynamic pressure, imposed loads, cross-bar pressures) | | 1.5 |
| Duration of loads typically encountered at trade fairs for k_{mod} , taken from DIN 18008-1, Table 6. | | Own weight: permanent ($k_{mod} = 0,25$) Working loads: medium ($k_{mod} = 0,4$) Horizontal substitute load: short ($k_{mod} = 0,7$) Cross-bar pressure: short ($k_{mod} = 0,7$) |

^{*)} German designations and abbreviations *Grenzzustand der Gebrauchstauglichkeit - GZG* and *Grenzzustand der Tragfähigkeit - GZT* [as listed in chapter 8] for the respective limit states.

For static load calculations, either concept A, comprehensive safety, or concept B, load factors, shall be used as a basis. The two concepts must not be mixed (used together). After the design dimension calculation concept A or B has been chosen, all design requirement specifications (e. g. flexing limits, glass clamping depth etc.) given in the set of standards chosen for the design concept are to be applied. The verbal description and the symbols and abbreviations used in equations must make it absolutely clear which concept is being applied. Supporting forces transmitted by glass components must always be stated for the SLS (GZG) and the ULS (GZT) so that the loads of the connected force-transmitting components of concrete, steel or wood can be calculated using the load-factor concept without transmission errors.

2.4 Material properties of glass products

Glass products have a bulk density of 25 kN/m³, a thermal expansion coefficient of 8.4·10⁻⁶/K and their Young's modulus is 70,000 N/mm². For structural design calculations, the bending stresses listed in *Table 1* are allowed (concept A) or the design calculation values of the resistance R_d listed in *Table 2* must be observed (concept B).

Table 1: Allowable bending stresses for various glass sorts, in N/mm² (for static proof calculations according to the allowable stress concept)

| | Toughened / fully-tempered glass (TSG) | Enamelled glass (printed glass) | | Heat-strengthened glass HSG | LSG made with float glass (PPG) | Float glass (polished plate glass PPG) | Wire glass (only for existing components) |
|------------------|--|---------------------------------|-----|-----------------------------|---------------------------------|--|---|
| | | TSG | HSG | | | | |
| Overhead glazing | 50 | 30 | 18 | 29 | 15 | 12 | 8 |
| Vertical glazing | 50 | 30 | 18 | 29 | 22,5 | 18 | 10 |

Table 2: Normal material properties for design calculation concept B, application of load factors

| Property | Polished plate glass (not printed, not sand-blasted) | HSG (not printed, not sand-blasted) | TSG (not printed, not sand-blasted) |
|---|--|--|--|
| Normal limit stress f _k as spec. in DIN EN 572-1, DIN EN 1863-1 or abZ, DIN EN ISO 12150-1 | 45 N/mm ² | 70 N/mm ² | 120 N/mm ² |
| Design coefficient k _c , normal | 1.8 | 1 | 1 |
| k _{LSG} for laminated safety glass | 1.1 | 1.1 | 1.1 |
| k _{edge} (k _{Kante}) for calculating the effect of glass edges | 0.8 | 1 | 1 |
| Material factor γ _M | 1.8 | 1.5 | 1.5 |
| Modification factor for calculating the effect of load durations | permanent: 0.25 medium duration: 0.4 short: 0.7 | | |
| Rated value of the resistance to stress failure R _d | $R_d = k_{mod} * k_c * k_{VSG} * k_{Kante} * f_k / \gamma_M$ | $R_d = k_c * k_{VSG} * k_{Kante} * f_k / \gamma_M$ | $R_d = k_c * k_{VSG} * k_{Kante} * f_k / \gamma_M$ |

The intermediate films in LSG shall be made of PVB or SGP (*SentryGlas® plus*). Films made of PVB must have a tear strength of at least 20 N/mm². SGP films shall have general approval by building authorities (including European Technical Approval ETA) and shall be processed in accordance with this approval.

3 STAND DESIGN, CONSTRUCTION AND LOADS

3.1 Vertical glazing not intended to prevent falling

3.1.1 Vertical glazing of a height h ≤ 4 metres above hall floor level

Neither static proof of structural characteristics in accordance with the regulations specified in chapter 2.3 is required, nor is it necessary to submit documentation of testing. In this case the exhibitor alone is responsible for ensuring that the construction/design is technically safe for general use and that it meets current and accepted technical standards. Table A provides an overview of the types of structural designs that are possible.

- Either TSG or LSG must be used.
- The glass sheets may be secured by linear supports or at individual points.
- Glass walls tilting at an angle of more than 10° from the vertical are considered to be overhead glazing for which the provisions of chapter 3.3 shall apply.
- Additional measures, e. g. provision of static proof calculations similar to those described in chapter 3.1.2, may be required to ensure protection of neighbouring walkways, or to be able to bear the loads of persons leaning against or bumping into the glass.

3.1.2 Vertical glazing of height h > 4 metres above hall floor level

Vertical glazing not intended to prevent falling and whose uppermost edges are higher than 4 metres above hall floor level does not require *Installation approval for a specific case* (c.f. 4.2) provided that the type of glass used, structural design details and the type of supports securing the glass comply with the regulations specified in chapter 2.3.

In addition, the following provisions shall be observed.

- Verified structural calculations or structural calculations suitable for verification and the corresponding construction plans must be submitted.
- In addition to the load of its own weight, the material must be capable of resisting horizontal forces, i. e. a pressure corresponding to at least $h_1 = 0.125 \text{ kN/m}^2$ for visible surfaces of up to 4 m above hall floor level and at least $h_2 = 0.063 \text{ kN/m}^2$ for visible surfaces at more than 4 m above hall floor level.
- Wherever there is a high risk of impact, e. g. where there is a descending ramp leading towards the glazing, additional measures are required.
- Proof of structural characteristics is not required if the area of each individual sheets is less than 1.6 m^2 and TSG with a thickness of at least 4 mm is used, and the sheet(s) is(are) held on four sides by linear supports.

Glazing secured at individual points may be used without further proof documentation if:

- general construction approval (*abZ*) has already been granted for the combination of point-mounting method and glass type and thickness, or
- the design specifications, and the dimensions and thickness of the glass as stated in TRAV, TRPV, DIN 18008-3, DIN 18008-4 or Table B are adhered to.

TRAV, DIN 18008-3 / -4 and Table B are referred to above because the fall-prevention glazing barriers described in these references are of course also suitable for glass panels not explicitly intended to prevent falls.

Installation approval for a specific case is required for all other designs.

If the use TSG glazing is planned, a heat soak test certificate must be submitted.

Table A provides an overview of possible designs and the necessary proofs.

3.2 Vertical glazing intended to prevent falls

In all three of the following categories, A, B and C, static load proof calculations for the glass and the supporting structures and proof of the load-bearing capacity under impact-like conditions are required.

The static structural design calculations for the glass and the supporting structure shall be based on an assumed cross-bar pressure load and as an additional load case, a horizontal assumed surface load of $h_1 = 0,125 \text{ kN/m}^2$ for all visible surfaces at up to 4 m above the hall floor level and of $h_2 = 0,063 \text{ kN/m}^2$ for surfaces located at more than 4 m above hall floor level.

The load-bearing capacity of the structure under impact action can be verified as follows:

- a pendulum impact test in accordance with DIN EN 12600 if design calculation concept A is used, or in accordance with DIN 18008-4 if design calculation concept B is used, or
- the relevant design specifications, glass dimensions and thicknesses as stated in Table B of this information sheet are adhered to, or
- by providing proof calculations in accordance with the rules described in chapter 2.3.

Table B contains an overview of possible designs and the proofs required. All structural design details (including flexing/sag and glass insertion/clamping depths) shall be modelled in accordance with the rules described in chapter 2.3. Pendulum impact tests must be carried out by one of the test centres/institutes named in chapter 4 well in advance of the fair and outside the trade fair halls.

3.2.1 Category A – vertical glass wall

Definition: Linearly-supported vertical glazing that does not contain any load-bearing bars at capping height and is not protected by a rail or cross-bar located in front of it, making it suitable for the direct action of rail or cross-bar loads, e. g. glazing of full room height.

If protection is required to prevent persons falling from a height of more than 1 metre, then it will be necessary to refer to the Technical Regulations for the Use of Accident-Prevention (barrier) Glazing [*Technische Regeln für die Verwendung von absturzsichernden Verglasungen (TRAV)*] or DIN 18008-4.

- Only LSG shall be used.
- Verified proof of structural characteristics or static structural calculations suitable for verification, as well as a pendulum impact test (test in accordance with DIN EN 12 600 or DIN 18008-4) are required.
- The pendulum impact test is not required for glass with linear support on all sides, provided that the appropriate dimensions and glass thickness conform to Table B (or TRAV 6.3. and Table 2), DIN 18008-3 and DIN 18008-4, or proof calculations are carried out in accordance with DIN 18008-4.
- The glazing supports must provide adequate protection to the edges of the glass sheets.

3.2.2 Category B – clamped glass balustrade with continuous handrail

Definition: Load-bearing glass balustrades held by linear supports secured by clamp-type base mountings, the individual glazing elements of which are connected by a continuous, load-bearing handrail (see example in chapter 6.1) attached to the top of the structure.

- Only LSG shall be used.
- Verified proof of structural characteristics or static structural calculations suitable for verification, as well as a pendulum impact test (test in accordance with DIN EN 12 600 or DIN 18008-4) are required.
- If LSG made of 2 x 10 mm TSG (or 2 x 10 mm HSG) is used, no pendulum impact test is required, provided that the dimensions as stated in Table B are adhered to (design details in accordance with TRAV or DIN18008-4).

- The thickness of the intermediate PVB/SGP film must be at least 1.52 mm.
- The securing clamps must be at least 100 mm above floor level.

Calculations shall be provided proving that the loads will be distributed via the capping to neighbouring glass sheets in the event of an individual sheet being destroyed. The stresses occurring in the neighbouring glass sheets under the resulting conditions may then increase to 50 % above permissible limits if structural design calculation concept A was applied. If structural design concept B has been applied, this case can be classified as an extraordinary design calculation situation. The destroyed or damaged glass sheet shall be replaced immediately after the incident.

3.2.3 Category C – Railing and balustrade infills and glass walls with load-distributing cross-bar fitted in front of it

Definition: Accident-prevention (barrier) glazing which is not intended to distribute capping loads and which corresponds to one of the following groups:

C1: Railing/balustrade infills secured by linear supports and/or at individual points on at least two opposing sides.

C2: Vertical glazing beneath a crosswise load-distributing spanning member located at capping level and secured by linear supports on at least two opposing sides.

C3: Category A type glazing with a load-distributing cross-bar placed in front of it.

- For category C1 and C2 type glazing, the use of TSG is allowed if the sheets are secured by linear supports on all sides. For all other types of supports and for category C3, only LSG may be used unless other statutory construction approval exists.
- Table B contains an overview of possible designs and the proofs required.
- The pendulum impact test is not required if the relevant design specifications and the dimensions and thickness of the glass as stated in Table B or TRAV or in DIN 18008-4 are adhered to.

Alternative measures / protection against glass breakage:

If the proof calculations for category C in accordance with TRAV or DIN 18008-4 are not submitted for accident-prevention (barrier) glazing, then the accident-prevention (barrier) attribute can be achieved by installing adequately sturdy knee-height cross-bars or steel rope of at least 5 mm diameter at a vertical spacing of not more than 35 cm and at an adequate distance in front of the glass infill sheets. Measures to protect against scattering glass splinters shall always be installed above and along the length of walkways, if this is not possible, LSG shall be used.

3.3 Horizontal glazing

3.3.1 Overhead glazing

Glass walls tilted at an angle of more than 10° from the vertical are considered to be overhead glazing. Table C contains an overview of possible designs and the proof documentation required.

Only the following glass products may be used:

- LSG made with float glass (PPG)
- LSG made of HSG,
- Wire glass (only for existing components)

In addition to submitting certification of load-bearing capacities, experimental proof of residual load-bearing capacities must be provided or, if this is not possible, a safety net must be hung under the glazing. If the structural design requirements of TRLV or as specified in DIN 18008-2 are met, proof of the residual load-bearing capacities is not required. The design loads to be assumed are the sheet's own weight and a horizontal pressure corresponding to at least $h_1 = 0.125 \text{ kN/m}^2$ for visible surfaces of up to 4 m above hall floor level or $h_2 = 0.063 \text{ kN/m}^2$ for vertical visible surfaces at more than 4 m above hall floor level.

The sheets must be secured in such a way as to properly safeguard against them slipping out of the mounts and forces which may lift them off the mounts.

The design dimensions of glass sheets mounted at individual points and HSG sheets shall either be calculated according to the rules outlined in chapter 2.3 or they must have general construction approval (*abZ*).

If, for cleaning purposes, overhead glazing periodically has to support human loads, then such additional loads must be taken into consideration and experimental proof of residual load-bearing capacities must be provided [8]. In such cases a *special individual construction approval* is always required.

- LSG sheets with an effective span exceeding 1.20 m shall be supported on all sides. The ratio between length and width may not exceed 3 to 1. The overall thickness of the intermediate PVB/SGP films must be at least 0.76 mm. If a sheet is supported on all sides, then a thickness of 0.38 mm is allowed under the condition that the length-to-width ratio is not greater than 3 to 1 and that the effective span in the direction bearing the main load is not greater than 0.8 m.
- The effective span of a wire glass sheet may not exceed 0.7 m, and the glass shall protrude into the supports by at least 15 mm.
- Cutting of recesses or notches in the glass sheets is not allowed.
- Only holes conforming to TRPV and/or DIN 18008-3 are allowed.
- The maximum permissible sag shall not exceed 1/100 of the effective span between the closer supports of the sheet.

3.3.2 Glazing designed to support human loads

This kind of glazing is specifically intended to be subjected to persons walking over it, e. g. stairs, platforms, landings and cat-walks. The design and proof calculations shall take both dead loads (own weight) and the working loads into account. In addition, proof of impact resistance and residual load-bearing capacity shall be provided.

Proof of impact resistance and residual load-bearing capacities as a result of component tests must be submitted. The requirements are specified in [8] and in DIN 18008-5.

For glazing mounted in linear supports at all four edges and an assumed working load of not more than 5.0 kN/m² for design calculations, proof of impact resistance and residual load-bearing capacity is deemed to have been provided if the sheets conform to the dimensions listed in Table 3.

Table 3: Glazing mounted in linear supports at all four edges and intended to support human loads, with proven impact resistance and residual load-bearing capacity.

| max. length [mm] | max. width: [mm] | LSG structure [mm] (top /*/ centre /*/ bottom) | Minimum supporting surface depth [mm] |
|------------------|------------------|--|---------------------------------------|
| 1500 | 400 | 8 HSG /*/ 10 Float /*/ 10 Float | 30 |
| 1500 | 750 | 8 HSG /*/ 12 Float /*/ 12 Float | 30 |
| 1250 | 1250 | 8 HSG /*/ 10 HSG /*/ 10 HSG | 35 |
| 1500 | 1500 | 8 HSG /*/ 12 HSG /*/ 12 HSG | 35 |
| 2000 | 1400 | 8 HSG /*/ 15 Float /*/ 15 Float | 35 |

/*/ = 1.52 mm PVB or SGP (*SentryGlas® plus*) intermediate film layer

Glazing designed to support human loads may be secured by linear supports or at individual points. It must be made of LSG consisting of at least three layers of TSG and/or HSG/float glass. From the point of view of impact resistance, the use of TSG or HSG for the top layer is recommended. This surface must possess non-slip characteristics in accordance with DIN 51097. In order to achieve the required residual load-bearing capacity, the two lower layers will normally be made of float glass or HSG.

Glazing, mountings and supporting structure must be designed and their dimensions calculated to withstand the load of their own combined weight (dead load) as well as intended human (working) loads in accordance with the chosen design calculation concept and all relevant and applicable standards.

| Design calculation concept | A (TRLV) | B (DIN 18008-5) |
|---|--|---|
| Working surface load q_k , depending on usage category | C1: 3.0 kN/m ² C3, T2: 5.0 kN/m ² | C1: 3.0 kN/m ² C3, T2: 5.0 kN/m ² |
| Point load Q_k , as an additional changing load parameter to be investigated | C1: 4.0 kN C3: 4.0 kN / T2: 2.0 kN | C1: 4.0 kN C3: 4.0 kN / T2: 2.0 kN |
| Application area of point load | 100 x 100 mm | 50 x 50 mm |
| Inclusion of top sheet in structural static calculations allowed | no | only for constant design situation and for temporary design situation |
| Proof calculation for situation with broken top sheet (i. e. only the two lower sheets still bear the load) | standard proof | proof for an extraordinary design load calculation situation |
| Standards relating to the action of loads | DIN EN 1991-1-1 DIN EN 1991-1-1 /NA | DIN EN 1991-1-1 DIN EN 1991-1-1 /NA |
| Max. sag / flexure with 3 load-bearing sheets | l/200 | l/200 |
| Max. sag / flexure with 2 load-bearing sheets | l/100 | l/100 |

In the case of stairways the construction/design must guarantee sufficient distribution of loads. Stairs on stand structures shall always be classified with usage category T2.

4 APPROVAL PROCEDURES

4.1 Basics

If a glass component and its glass products conform to the technical building regulations outlined in chapter 2.3 and to generally accepted technical principles, then it shall be sufficient to submit the verified structural calculations and the verified plans, following which construction approval will be granted. In addition, the construction work on site will be checked and the results subjected to an approval inspection.

If additional components are installed for which statutory construction approval, a statutory construction test report or type approval are required, then these documents are to be submitted together with the structural calculations.

If a glass component or parts of this component do not conform to the construction engineering regulations and generally accepted technical principles outlined in chapter 2.3, and if no statutory construction approval or statutory construction test certificate can be produced, then an *individual construction approval (Zustimmung im Einzelfall – ZiE)* shall be required. An **Installation Approval for a Specific Case** may be granted instead of the individual construction approval if glass is used only within the rules and limitations described in this information sheet.

4.2 Installation approval for a specific case

This approval procedure is similar to the procedure for obtaining individual construction approval. If an **Installation Approval for a Specific Case** has been granted once for a particular construction/design and type of usage, then the trade fair companies in question will accept this for an identical design serving an identical purpose. Nevertheless, a new application for construction work approval and approval inspection shall be submitted for each repeated case. The test report, all certificates and approvals, design details, as well as glass dimensions and thicknesses must be submitted with the application.

Glass components requiring approval and which require type 3 proof documentation are listed in column 14 of Tables A, B and C.

Installation approvals for specific cases cannot be granted at short notice, as they require a considerable period of time for processing. Applications for these should therefore be submitted at least 6 weeks before the commencement of construction.

Prior to conducting component tests, it is advisable to contact the relevant trade fair company in good time in order to coordinate procedures and intended testing methods. Normally, component testing requirements stipulate inclusion of parts of the glass component's actual substructure in order to simulate realistic loads.

The procedure for obtaining an **Installation Approval for a Specific Case** is as follows:

- The structural calculations and the required certificates confirming the identity of the product(s) (glass manufacturer/processing company's factory certificates) must be verified and checked by a publicly certified structural building surveyor and tester (in the field of steel, concrete and brick construction/engineering).
- The surveyor shall confirm that there are no objections with regard to the design's suitability for use. It is his responsibility to decide on the necessity of additional testing of materials, impact resistance and whether further proof of residual load-bearing capacities must be obtained. The test report must be submitted to the trade fair company along with the other application documents requesting construction work permit (construction permit) and subsequent monitoring of the stand construction work and stand approval inspection.
- Final approval will be granted on location following an inspection to confirm that the construction/design on site conforms to the previously inspected documents. The engineer carrying out the monitoring and inspection acts on behalf of the trade fair company.

Recommended institutes for testing components used in glass construction/design:

Technische Universität Dresden,
Institut für Baukonstruktionen (Beyer-Bau)
Prof. Dr.-Ing. Weller
George-Bähr-Str. 1
01069 Dresden

MFPA Leipzig GmbH
Hans-Weigel-Str. 2B
04319 Leipzig

TU Hamburg - Harburg
Institut für Baustatik und Stahlbau
Prof. Dr.-Ing. Starossek
Denickestr. 7
21073 Hamburg

Institut für Massivbau
Prof. Dr.-Ing. Marx
Leibnitz-Universität Hannover
Appelstr. 9a
30167 Hannover

Materialprüfanstalt für das
Bauwesen Braunschweig
Beethovenstr. 52
38106 Braunschweig

MPA Nordrhein-Westfalen
Marsbruchstr. 186
44287 Dortmund

RWTH Aachen
Lehrstuhl für Stahlbau
Prof. Dr.-Ing. Feldmann
Mies-van-der-Rohe-Str. 1
52074 Aachen

MPA Darmstadt
Grafenstr. 2
64283 Darmstadt

TU Darmstadt
Institut für Werkstoffe und Mechanik
im Bauwesen
Prof. Dr.-Ing. Wörner
Petersenstr. 12
64283 Darmstadt

FMPA Baden-Württemberg
FB 2, Abt. 21, Referat 214
Pfaffenwaldring 4
70569 Stuttgart (Vaihingen)

Universität Karlsruhe
Versuchsanstalt für
Stahl, Holz und Steine
Prof. Dr.-Ing. Ummenhofer
Otto-Amman-Platz 1
76131 Karlsruhe

Friedmann & Kirchner
Gesellschaft für Material-
und Bauteilprüfung
Große Ahlmühle 7
76865 Rohrbach

FH München
Labor für Stahl- und Leichtmetallbau
Prof. Dr.-Ing. Bucak
Karlst. 6
80333 München

TU München
Lehrstuhl für Stahlbau
Prof. Dr.-Ing. Mensinger
Arcisstr. 21
80333 München

Institut für Fenstertechnik e.V.
Theodor-Griehl-Str. 7-9
83025 Rosenheim

5 NOTES ON DESIGN AND DESIGN CALCULATIONS

- Glass is a brittle material, any failure of which will occur spontaneously and without warning.
- Glass is sensitive to blows with hard, pointed objects.

These properties lead to the following guideline notes:

- Proof calculations for the load-bearing capacity of structural glass not only take into consideration the unbroken glass but always include an investigation of the broken or partially broken glass (proof of residual load-bearing capacity).
- The support design must ensure that glass sheets are not subjected to pressure or stresses by the supports.
- Direct glass-to-glass contact and contact between glass and other hard materials (e.g. metal) shall be prevented at all times, whereby the effects of load and temperature fluctuations have to be taken into account.
- The minimum supporting depths of glass sheets ("glass insertion depth") on their respective support sections as well as the allowable sheet and supporting beam sections as specified in the standards listed in chapter 2.3 for the selected design calculation concept must be adhered to.
- After glazing has been installed, the markings identifying the individual type of glass sheet used (e.g. TSG, HSG) must be durable and legible at all times. In the case of LSG glazing, a section of the edge must be left free for inspection purposes (to check the number of glass sheets, thickness, interlayer films) until the construction has been approved. If required, a manufacturer's certificate shall be submitted as well.
- The edges of glass sheets must be finished or protected in such a way as to exclude any possibility of injury.
- In the case of TSG, HSG, or LSG glazing manufactured from sheets of TSG or HSG, subsequent reworking of the finished product such as cutting out sections or drilling holes is not possible.
- Sheets intended to bear human loads must have a durable non-slip surface finish.
- Load-bearing adhesive joints may only be used if a general construction approval (*abZ*) has been granted for the entire adhesive system (i. e. the glass, adhesive and metal combination), and under the condition that the joint is made exactly as described in the approval documents.
- The rules described in chapter 2.3 do not yet make allowance for applying more favourable assumptions of the joint effect of the intermediate film layers in LSG and therefore an **Installation Approval for the Specific Case** has to be applied for if these assumptions are used in calculations. Trade publications [18] contain information on suitable calculation assumptions to account for the joint effects in LSG. This may possibly be useful for LSG in which SGP is used.

6 EXAMPLES OF STRUCTURES (BARRIERS) DESIGNED TO PREVENT FALLS

All possible dimensions, types of glass, thicknesses and the necessary proof documents are summarised in Table B.

6.1 Category B

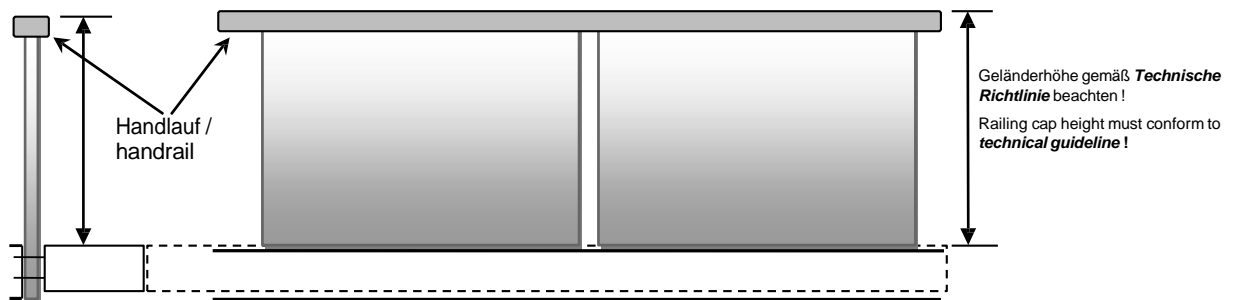

Note: If LSG made of 10 mm TSG + 1.52 mm PVB/SGP + 10 mm TSG or of 10 mm HSG + 1.52 mm PVB/SGP + 10 mm HSG in the dimensions as stated in Table B is used, only static structural proof calculations are required. As specified in TRAV or DIN 18008-4, this also applies to parallelogram-shaped balustrades.

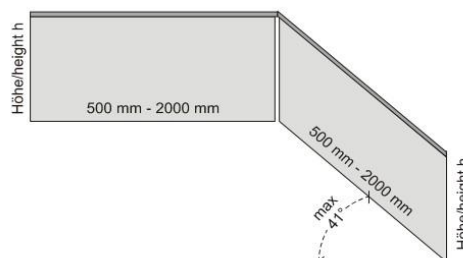

6.2 Category C1

6.2.1 Railing infills secured vertically on 2 sides

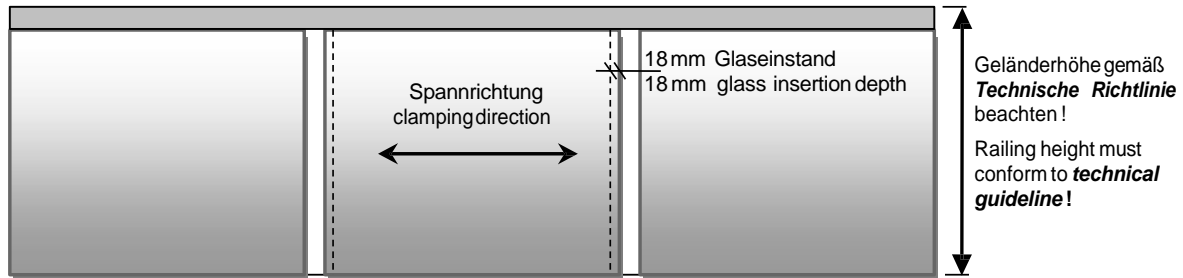

Note: If the types of glass and the dimensions listed in Table B are used, only static structural proof calculations are required.

6.2.2 Railing infills secured horizontally on 2 edges

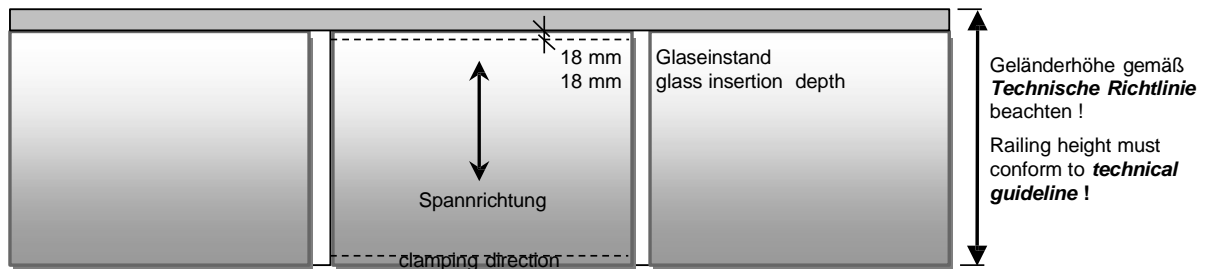

Note: If the types of glass and the dimensions listed in Table B are used, only static structural proof calculations are required.

6.2.3 Railing infills secured on 4 sides

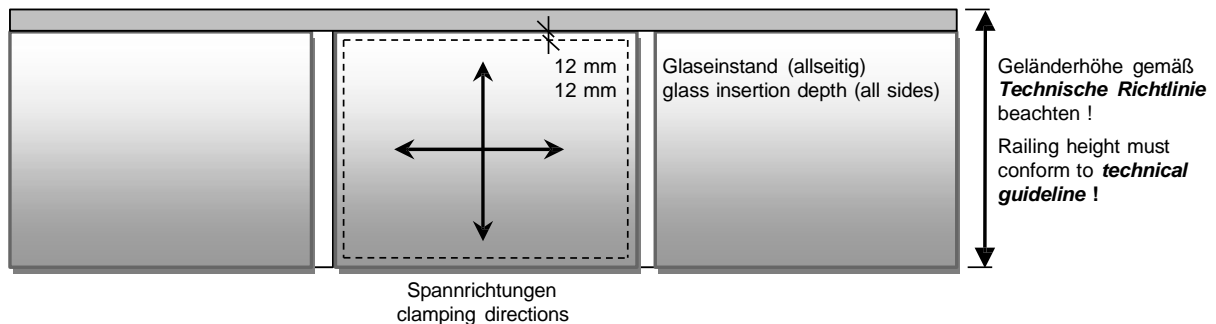

Note: If the types of glass and the dimensions listed in Table B are used, only static structural proof calculations are required.

6.2.4 Glazing secured at individual points by means of drilled anchorage points (design specifications in accordance with TRAV and/or DIN 18008-4)

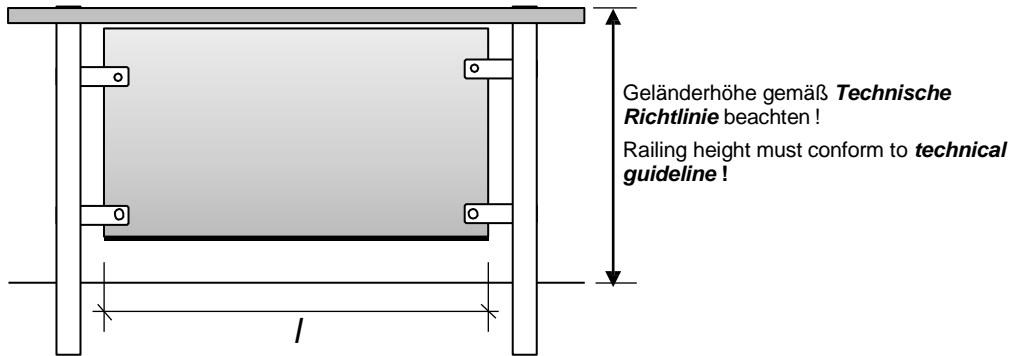

Note: If the types of glass and the dimensions listed in Table B are used, only static structural proof calculations are required.

In accordance with Appendix D of TRAV 2003 and DIN 18008-4, the rules for Categories C1 and C2 also apply to parallelogram-shaped balustrades.

Category C1

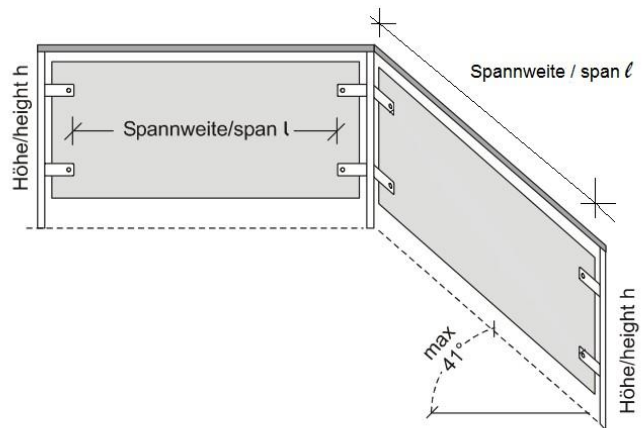

Kategorie C2/Category C2

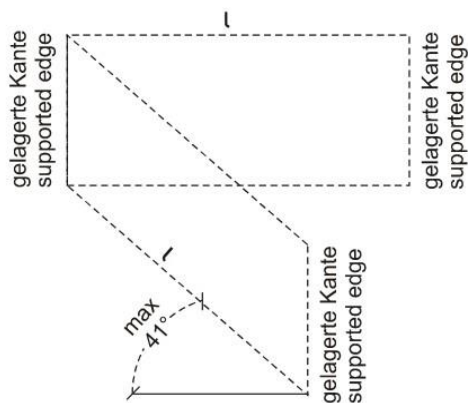

6.2.5 Point mounting with lateral clamps and anti-slip grips

- Designs that have a general construction approval (*abZ*) shall be used in accordance with.
- For all systems that have not been granted general construction approval, a pendulum impact test is required. Minimum requirement: LSG comprising 6 mm TSG + 1.52 mm PVB + 6 mm TSG or 6mm HSG + 1.52 mm PVB + 6 mm HSG shall be used.

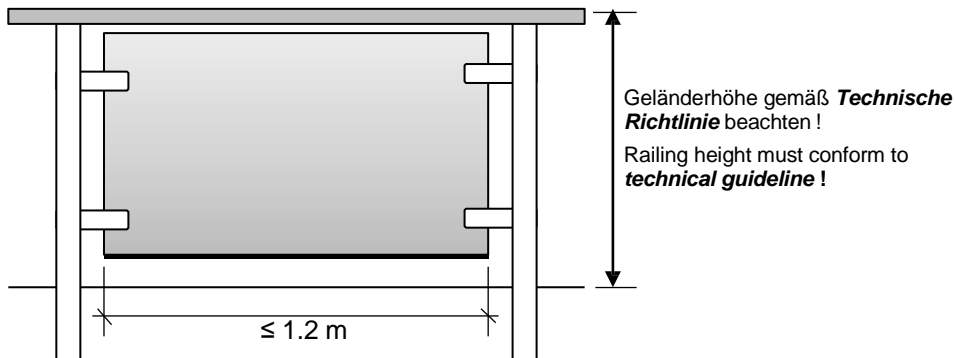

6.2.6 Point mounting with clamps at top and bottom

- System designs that have a general construction approval (*abZ*) shall be used in accordance with the specifications in the approval documents.
- For all systems that have not been granted general building approval, a pendulum impact test is required. Minimum requirement: LSG comprising 6 mm TSG + 1.52 mm PVB + 6 mm TSG or 6mm HSG + 1.52 mm PVB + 6 mm HSG shall be used.

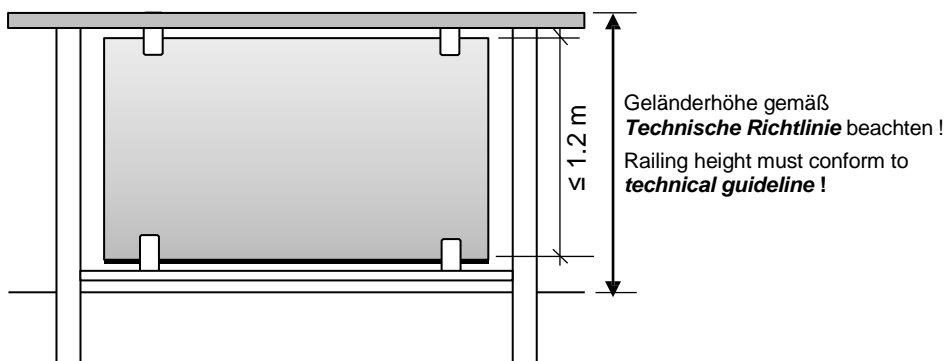

6.3 Balustrade with horizontal bars (protection against falling is provided solely by sufficiently strong handrails and knee-height bars)

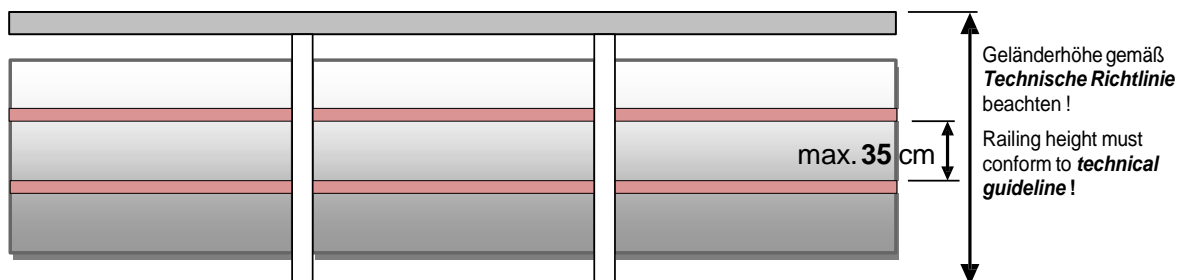

The type of glass used shall be selected from Table A, glazing not intended to protect against falls. The spacing between horizontal bars should not exceed approx. 35 cm.

7 CONSTRUCTION ENGINEERING REGULATIONS, GENERALLY ACCEPTED RULES OF ENGINEERING AND REFERENCES

- [1] *Wörner J.-D., Schneider J., Fink A.*: title "Glasbau: Grundlagen, Berechnung, Konstruktion", published by Springer-Verlag, Berlin Heidelberg; 2001
- [2] *Kuhlmann U.*: Stahlbau Kalender. Published by Ernst & Sohn Verlag für Architektur und technische Wissenschaften GmbH, Berlin, 1999
- [3] *Sedlacek S., Blank K., Laufs W., Güsgen J.*: title "Glas im Konstruktiven Ingenieurbau". (1. Aufl.) Ernst & Sohn Verlag für Architektur und technische Wissenschaften GmbH, Berlin, 1999
- [4] *Siebert G.*: title "Entwurf und Bemessung von tragenden Bauteilen aus Glas". Published by Ernst & Sohn Verlag für Architektur und technische Wissenschaften GmbH, Berlin, 2001
- [5] Technische Regeln für die Verwendung von linienförmig gelagerten Verglasungen [Technical rules for the use of glazing with linear supports] (**TRLV**) (final version of August 2006) DIBT
- [6] *Technische Regeln für die Verwendung von absturzsichernden Verglasungen* [Technical rules for the use of accident-prevention (barrier) glazing] (**TRAV**), (final version of January 2003)
- [7] Landesgewerbeamt Baden-Württemberg, Landesstelle für Bautechnik, Merkblatt G 2, Zusammenfassung der wesentlichen Anforderungen an zustimmungspflichtige Vertikalverglasungen (Fassung 28.7.1999)
- [8] Communications (Mitteilungen) of DIBt no. 2 / 2001: Anforderungen an begehbare Verglasungen; Empfehlungen für das Zustimmungsverfahren - Fassung März 2000 -, Berlin
(Requirements on glazing intended to be walked on, recommendations for approval procedures Version of March 2000 – Berlin)
- [9] *Wörner, J.-D.; Schneider J.*: Closing report on experiments and calculations to determine the dynamic stresses on glass as a result of a light impact, Fraunhofer IRB Verlag Stuttgart 2000, Booklet T 2935
- [10] *Völkel, G.E.; Rück R.*: Investigation into panes with linear support on 4 sides when subjected to impact, Fraunhofer IRB Verlag Stuttgart 2000, Booklet T 2915
- [11] *Weller, B., Nicklisch, F., Thieme, S. Weimar, T.*: Glasbau-Praxis in Beispielen, Konstruktion und Berechnung, Bauwerk-Verlag 2.Aufl. 2010
- [12] **DIN 18008-1** (December 2010) Glass in Building - Design and construction rules - Part 1: Terms and general bases
- [13] **DIN 18008-2** (December 2010) Glass in Building - Design and construction rules - Part 2: Linearly supported glazings
- [14] **DIN 18008-3** (October 2011) – *DRAFT*– Glass in Building - Design and construction rules - Part 3: Point fixed glazing
- [15] **DIN 18008-4** (October 2011) – *DRAFT*– Glass in Building - Design and construction rules - Part 4: Additional requirements for barrier glazing
- [16] **DIN 18008-5** (October 2011) – *DRAFT*– Glass in Building - Design and construction rules - Part 5: Additional requirements for walk-on glazing
- [17] Technische Regeln für die Bemessung und die Ausführung punktförmig gelagerter Verglasung [Technical rules for the use of glazing with supports at individual points] (**TRPV**), (final version August 2006), DIBT.
- [18] *Wellershof, F.*: Bemessungsschubmodule für Verbundglasscheiben, Stahlbau 76 (März 2007), H.3, pp. 177-188
- [19] Building rules list (see www.dibt.de)
- [20] ETB-Richtlinie: Bauteile, die gegen Absturz sichern (June 1985)
(ETAss directive: Building components designed to prevent falls)

8 ABBREVIATIONS

| Abbreviation | |
|--------------|--|
| abZ | German: <i>Allgemeine bauaufsichtliche Zulassung</i> (general construction approval) |
| C1, C3 | Categories for vertically acting working loads on floors of public meeting spaces in buildings as specified in DIN EN 1991-1-1 / NA |
| DIBt | <i>Deutsches Institut für Bautechnik</i> (German civil engineering institute) |
| ESG | German: <i>Einscheiben-Sicherheitsglas</i> (fully-tempered glass / toughened safety glass) |
| HSG | Heat-strengthened glass |
| LSG | Laminated safety glass |
| PPG | Polished plate glass |
| PVB | polyvinyl butyral (intermediate film material for LSG) |
| SGP | SentryGlas® plus (intermediate film material for LSG) |
| SLS | Serviceability limit state |
| SLS | Serviceability limit state |
| SPG | German: <i>Spiegelglas</i> (float glass or PPG) |
| T2 | Category for vertically acting working loads on stairs / staircase landings for large traffic loads and escape staircases as specified in DIN EN 1991-1-1 / NA |
| TRAV | <i>Technische Regeln für die Verwendung von absturzsichernden Verglasungen</i> [Technical rules for the use of accident-prevention (barrier) glazing] |
| TRLV | <i>Technische Regeln für die Verwendung von linienförmig gelagerten Verglasungen</i> [Technical rules for the use of glazing with linear supports] |
| TRPV | <i>Technische Regeln für die Bemessung und die Ausführung punktförmig gelagerter Verglasung</i> [Technical rules for the use of glazing with supports at individual points] |
| TSG | Toughened safety glass |
| TVG | German: <i>Teilvorgespanntes Glas</i> (heat-strengthened glass) |
| ULS | Ultimate limit state |
| VSG | German: <i>Verbund-Sicherheitsglas</i> (laminated safety glass) |
| ZiE | German: <i>Zustimmung im Einzelfall</i> (individual construction approval) |

9 Keyword index

| | | | |
|--|-------|---|------|
| Abbreviations | 16 | impact resistance..... | 8, 9 |
| acrylic glass..... | 3 | <i>individual construction approval</i> | 9 |
| anti-slip / anti-skid surface..... | 8 | infills | 7 |
| approval | | Installation Approval for a Specific Case | 9 |
| European Technical Approval..... | 3 | laminated safety glass | 3 |
| general construction approval..... | 3 | landings | 8 |
| procedures..... | 9 | limit stress..... | 4 |
| balustrade infills | | limit stress f_K | 5 |
| category B | 7, 11 | load factor..... | 4 |
| category C | 7 | LSG | 3 |
| category C1..... | 12 | Makrolon..... | 3 |
| category C2..... | 13 | manufacturer's certificate | 11 |
| balustrades..... | 7 | <i>material properties</i> | 5 |
| barrier glazing..... | 6 | overhead glazing | 7 |
| <i>bending stresses</i> | | pendulum impact tests..... | 6 |
| allowable..... | 5 | polished plate glass | 3 |
| building surveyor | 9 | polycarbonate products..... | 3 |
| category A | 6 | PPG | 3 |
| category B..... | 7, 11 | railings..... | 7 |
| cat-walks | 8 | rated value of the resistance to stress failure R_d | 5 |
| combination of point-mounting method and glass type/thickness | 6 | residual load-bearing capacities..... | 3, 7 |
| component tests..... | 7 | safety net..... | 7 |
| construction approval | | sag | |
| documents for application..... | 9 | maximum, for human loads..... | 8 |
| procedures..... | 9 | permissible | 8 |
| design calculation concepts | 4 | serviceability limit state | 4 |
| design notes | 11 | slip prevention | 8 |
| duration of load action | 4 | SLS | 4 |
| pressure, horizontal..... | 6 | splinter protection..... | 7 |
| experimental proof..... | 7 | stairs..... | 8 |
| float glass | 3, 5 | structural design standards | 4 |
| general approval by building authorities | 5 | supports/mounting, types | 3 |
| general construction approval | 3 | tempered safety glass | 3 |
| glass wall | 6, 7 | test report | 9 |
| glazing | | testing institutes..... | 6, 9 |
| horizontal | 7 | TRAV..... | 4, 6 |
| intended to prevent falls | 6 | TRLV..... | 4, 7 |
| overhead..... | 7 | TRPV..... | 4, 6 |
| supporting human loads | 8 | TSG | 3 |
| vertical | 6 | type approval | 9 |
| heat soak test certificate | 6 | types of supports..... | 3 |
| heat-strengthened glass | 3 | ULS | 4 |
| HSG..... | 3 | ultimate limit state | 4 |

Use of glass and acrylic glass in stand construction and design inside trade fair halls

| | | |
|------------------------|-------------------------|---|
| | action duration | 4 |
| | usage category C1..... | 7 |
| | usage category C3..... | 7 |
| | usage category T2:..... | 8 |
| vertical glazing | 5, 6 | |
| wire glass | 5, 7 | |
| span..... | 8 | |
| working loads | 8 | |

Table A: Vertical glazing, not intended to prevent falls

| 1 | 2 | 3 | 4 | 5 | 6 | 7 | 8 | 9 | 10 | 11 | 12 | 13 | 14 | 15 | | |
|------------------|-------------------------------|--|---------------------------|---------------|-----------------|-----------------------|--------------------------|-------------|-----|--------------|-----|----------------------------------|------------------------|-------------------------|-----------------|---|
| Structure type | | | | | Allowed, yes/no | Glass thickness in mm | SGP / PVB film thickness | Width in mm | | Height in mm | | Min. glass insertion depth in mm | Type of proof required | Civil engineering rules | | |
| Type | Character-istic | Structure | Sheet support | Glass type | | | | min | max | min | max | | | | | |
| Vertical glazing | not intended to prevent falls | Glass wall ≤ 4.0 m above floor level | Linear support on 2 sides | TSG | yes | | | | | | | | 1 | | | |
| | | | | LSG 2 layers | yes | | | | | | | | | 1 | | |
| | | | | Wire glass | yes | | | | | | | | | | 1 | |
| | | | | Acrylic glass | yes | | | | | | | | | | 1 | |
| | | | Linear support on 4 sides | TSG | yes | | | | | | | | | | 1 | |
| | | | | LSG 2 layers | yes | | | | | | | | | | 1 | |
| | | | | Wire glass | yes | | | | | | | | | | 1 | |
| | | | | Acrylic glass | yes | | | | | | | | | | 1 | |
| | | | Pointsupports | TSG | yes | | | | | | | | | | 1 | |
| | | | | LSG 2 layers | yes | | | | | | | | | | 1 | |
| | | | | Wire glass | no | | | | | | | | | | | |
| | | | | Acrylic glass | yes | | | | | | | | | | 1 | |
| | | Glass wall > 4.0 m above floor level | Linear support on 2 sides | TSG | yes | | | | | | | | | | 2, 5 | A |
| | | | | LSG 2 layers | yes | | | | | | | | | | 2 | A |
| | | | | Wire glass | yes | | | | | | | | | | 2 | A |
| | | | | Acrylic glass | yes | | | | | | | | | | 1 | |
| | | | Linear support on 4 sides | TSG | yes | | | | | | | | | | 2 ¹⁾ | A |
| | | | | LSG 2 layers | yes | | | | | | | | | | 2 ¹⁾ | A |
| | | | | Wire glass | yes | | | | | | | | | | 2 ¹⁾ | A |
| | | | | Acrylic glass | yes | | | | | | | | | | 1 | |
| | | | Pointsupports | TSG | yes | | | | | | | | | | 2, 3, 5 | C |
| | | | | LSG 2 layers | yes | | | | | | | | | | 2, 3 | C |
| | | | | Acrylic glass | yes | | | | | | | | | | 1 | |
| | | | | Wire glass | no | | | | | | | | | | | |
| | | Railing infill system with cross-bar and fall-prevention crossbars at knee-height (the actual glass sheet has no barrier function) | Linear support on 2 sides | TSG | yes | | | | | | | | | | 1, 5 | |
| | | | | LSG 2 layers | yes | | | | | | | | | | 1 | |
| | | | | Wire glass | yes | | | | | | | | | | 1 | |
| | | | | Acrylic glass | yes | | | | | | | | | | 1 | |
| | | | Linear support on 4 sides | TSG | yes | | | | | | | | | | 1 | |
| | | | | LSG 2 layers | yes | | | | | | | | | | 1 | |
| Wire glass | yes | | | | | | | | | | | | 1 | | | |
| Acrylic glass | yes | | | | | | | | | | | | 1 | | | |
| Pointsupports | TSG | | yes | | | | | | | | | | 1, 5 | | | |
| | LSG 2 layers | | yes | | | | | | | | | | 1 | | | |
| | Wire glass | | no | | | | | | | | | | | | | |
| | Acrylic glass | | yes | | | | | | | | | | 1 | | | |

| | | | | |
|-----------|----------------------|------------------------------------|---------------------------------|-------------------------|
| Proof by: | 1: No specific proof | 2: Verified static calculations | 3: Installation appr. for spec. | 4: Pendulum impact test |
| | 5: Heat soak test | 6: Residual load-bearing cap. test | 7: Shock impact resistance test | |

| | | | |
|--------------------------|--------------------------|--------------------------|------------------------|
| Civil engineering rules: | A: TRLV or DIN 18008-1/2 | B: TRAV or DIN 18008-1/2 | C: TRPV or DIN 18008-3 |
|--------------------------|--------------------------|--------------------------|------------------------|

1) Proof type 2 (verified static design calculations) are not required for sheet areas $A \leq 1.6 \text{ m}^2$ and $d \geq 4 \text{ mm}$

Table B: Vertical glazing, intended to prevent falls (barrier glazing)

| 1 | 2 | 3 | 4 | 5 | 6 | 7 | 8 | 9 | 10 | 11 | 12 | 13 | 14 | 15 | | | |
|--|-------------------------------------|---|----------------------------------|--------------|-----------------|-----------------------|--------------------------|-------------------|--------------------|--------------------|--------------------|----------------------------------|------------------------|-------------------------|------|------|------|
| Structure type | | | | | Allowed, yes/no | Glass thickness in mm | SGP / PVB film thickness | Width in mm | | Height in mm | | Min. glass insertion depth in mm | Type of proof required | Civil engineering rules | | | |
| Type | Character-istic | Structure | Sheet support | Glass type | | | | min | max | min | max | | | | | | |
| Vertical glazing | Fall-prevention, barrier (Dh > 1 m) | Glass wall (cat. A as defined in TRAV) | Linear support on 2 sides | TSG | no 2) | | | | | | | 18 | 2, 4 | A, B | | | |
| | | | | LSG 2 layers | yes | | 0,76 | | | | | | | | | | |
| | | | Linear support on 4 sides | TSG | no 2) | | | | | | | | | | | | |
| | | | | LSG 2 layers | yes | 2x6 Float | 0,76 | 500 | 1200 | 1000 | 2000 | | 12 | 2 | | A, B | |
| | | | | | 2x8 Float | 0,76 | 500 | 1500 | 1000 | 2500 | | | | | | | |
| | | | | | 2x10 Float | 0,76 | 1200 | 2100 | 1000 | 3000 | | | | | | | |
| | | | | | 2x6 Float | 0,76 | 500 | 2000 | 1000 | 1200 | | 12 | 2 | | A,B | | |
| | | | | | 2x8 Float | 0,76 | 500 | 2500 | 1000 | 1500 | | 12 | 2 | | A,B | | |
| | | | | 2x10 Float | 0,76 | 1000 | 3000 | 1200 | 2100 | | 12 | 2 | | A,B | | | |
| | | | | 2x6 Float | 0,76 | 300 | 500 | 500 | 3000 | | 12 | 2 | | A,B | | | |
| | | | Point supports | TSG | no 2) | | | | | | | | | | | | |
| | | | | LSG 2 layers | yes | 2x10 HSG | 1,52 | | 1200 ³⁾ | | 1600 ³⁾ | | 4) | 2 | | B, C | |
| | | | | LSG 2 layers | yes | 2x8 TSG | 1,52 | | 1200 ³⁾ | | 1600 ³⁾ | | 4) | 2 | | B, C | |
| | | | | LSG 2 layers | yes | 2x10 TSG | 1,52 | | 1600 ³⁾ | | 1800 ³⁾ | | 4) | 2 | | B, C | |
| | | LSG 2 layers | | yes | 2x10 TSG | 1,52 | | 800 ³⁾ | | 2000 ³⁾ | | 4) | 2 | | B, C | | |
| | | LSG 2 layers | | yes | | 0,76 | | | | | | | | 2, 3, 4 | B, C | | |
| | | Balustrade/parapet clamped at the bottom, with handrail (cat. B as defined in TRAV) | Linear clamping at one edge | TSG | no | | | | | | | | | | | | |
| | | | | LSG 2 layers | yes | 2x10 TSG | 1,52 | 500 | 2000 | 900 | 1100 | 100 | 2 | | A, B | | |
| | | | | | | | | 2x10 HSG | 18994 | 500 | 2000 | 900 | 1100 | 100 | 2 | A, B | |
| | | Railing infill (cat. C1 and C2 as defined in TRAV) | Linear support at top and bottom | TSG | no 2) | | | | | | | | | | | | |
| | | | | LSG 2 layers | yes | 2x6 Float | 0,76 | 1000 | | | 800 | | | 18 | 2 | | A, B |
| | | | | | 2x5 TSG | 0,76 | 800 | any desired | 500 | 1100 | | | | | | | |
| | | | | 2x8 Float | 1,52 | 800 | | | 1100 | | | | | | | | |
| | | | Linear support at left and right | TSG | no 2) | | | | | | | | | | | | |
| | | | | LSG 2 layers | yes | 2x6 Float | 0,76 | | 800 | 1000 | | 1100 | 18 | 2 | | A,B | |
| | | | | | 2x8 Float | 1,52 | | 500 | 1100 | 800 | | 1100 | | | | | |
| | | | LSG 2 layers | yes | | | | | | | | 12 | 2, 4 | | A, B | | |
| | | | Linear support on 4 sides | TSG | yes | | | | | | | | 12 | 2 | | | |
| LSG 2 layers | yes | | | 2x5 Float | 0,76 | 500 | 2000 | 500 | 1000 | | 12 | 2 | | | | | |
| Railing infill (only cat. C1 as defined in TRAV) | Point supports | TSG | no 2) | | | | | | | | | | | | | | |
| | | LSG 2 layers | yes | 2x6 TSG | 1,52 | | 1200 | | 700 | 10 | 2 | | B, C | | | | |
| | | | 2x8 TSG | 1,52 | | 1600 | | 800 | | | | | | | | | |
| | | LSG 2 layers | yes | 2x8 HSG | 1,52 | | 1600 | | 800 | 10 | 2 | | B, C | | | | |
| | LSG 2 layers | yes | 2x6 HSG | 1,52 | | 1200 | | 700 | | | | B, C | | | | | |
| Glass wall with load-bearing / protective handrail in front of it (cat. C3 as defined in TRAV) | Linear support on 2 sides | TSG | no 2) | | | | | | | | | 18 | 2, 4 | A, B | | | |
| | | LSG 2 layers | yes | | | | | | | | | | | | | | |
| | Linear support on 4 sides | TSG | no 2) | | | | | | | | | | | | | | |
| | | LSG 2 layers | yes | 2x5 PPG | 0,76 | 500 | 1500 | 1000 | 3000 | | 12 | 2 | | A, B | | | |
| | Point supports | TSG | no 2) | | | | | | | | | | | | | | |
| | | yes | | | | | | | | | | 2, 3, 4 | B, C | | | | |

| | | | | |
|-----------|----------------------|------------------------------------|--------------------------------------|-------------------------|
| Proof by: | 1: No specific proof | 2: Verified static calculations | 3: Installation appr. for spec. case | 4: Pendulum impact test |
| | 5: Heat soak test | 6: Residual load-bearing cap. test | 7: Shock impact resistance test | |

| | | | |
|--------------------------|--------------------------|------------------------|------------------------|
| Civil engineering rules: | A: TRLV or DIN 18008-1/2 | B: TRAV or DIN 18008-4 | C: TRPV or DIN 18008-3 |
|--------------------------|--------------------------|------------------------|------------------------|

Note: where decimal fractions are listed in the table, a comma is used instead of a decimal point to permit the same table contents to be used for all language versions.

If a pendulum impact test, proof type "4", is not specified in column 14, then this advantage is subject to adherence to the limit values stated in columns 7 to 13. Structural designs not listed here will require an Installation Approval for the Specific Case.

2) In systems having a valid general statutory construction approval, LSG may be used in accordance with the text of the approval documents.

3) The distance between neighbouring point supports in x-direction and in y-direction, respectively.

4) Clamped on both faces by circular plates with diameter d >= 50 mm, if spacing is greater than 1200 mm, plate diameter shall be d >= 70 mm, see DIN 18008-3/4

The use of acrylic glass and wire glass is not allowed for vertical glazing intended to prevent falls (barrier glazing).

If the sheets are held in linear supports, LSG made of HSG and with the same specified thicknesses may be used instead of LSG made of float glass.

Table C: Horizontal glazing

| 1 | 2 | 3 | 4 | 5 | 6 | 7 | 8 | 9 | 10 | 11 | 12 | 13 | 14 | 15 | | | |
|--------------------|--|---|-----------------------------|-------------------------------|-----------------|--|--------------------------|--------------------|------|-------------|------------|----------------------------------|------------------------|-------------------------|-----------------|---|--|
| Structure type | | | | | Allowed, yes/no | Glass thickness in mm top /' centre /' bottom /' = 1.52 mm PVB / SGP | SGP / PVB film thickness | Length in mm | | Width in mm | | Min. glass insertion depth in mm | Type of proof required | Civil engineering rules | | | |
| Type | Characteristic | Structure | Sheet support | Glass type | | | | min | max | min | max | | | | | | |
| Horizontal glazing | Overhead glazing (angled at > 10° to the vertical) ³⁾ | | Linear support on 2 sides | TSG | no | | | | | | | | | | | | |
| | | | | LSG 2 layers | yes | 0,76 | | 1200 ⁴⁾ | | | | 2 ⁵⁾ | A | | | | |
| | | | | Wire glass | yes | | 700 ⁴⁾ | | | 15 | 2 | A | | | | | |
| | | | Linear support on 4 sides | TSG | no | | | | | | | | | | | | |
| | | | | LSG 2 layers | yes | 0,76 | | | | | | | | 2 ⁵⁾ | A | | |
| | | | | Wire glass | yes | | 700 ⁴⁾ | | | 15 | 2 | A | | | | | |
| | | Point supports | TSG | no | | | | | | | | | | | | | |
| | | | LSG 2 layers | yes | 1,52 | | | | | | | | 2, 3, 6 ⁶⁾ | C | | | |
| | | | Wire glass | no | | | | | | | | | | | | | |
| | | Glazing capable of supporting persons (to be walked on) | Installed at height < 20 cm | Linear support on 2 sides | TSG | no | | | | | | | | | | | |
| | | | | | LSG 2 layers | no | | | | | | | | | | | |
| | | | | | LSG 3 layers | yes | | | | | | | | 30 | 2 ⁵⁾ | A | |
| | Wire glass | | | | no | | | | | | | | | | | | |
| | Linear support on 4 sides | | | | TSG | no | | | | | | | | | | | |
| | | | | | LSG 2 layers | no | | | | | | | | | | | |
| | | | | LSG 3 layers | yes | 8 HSG /' 10 Float /' 10 Float | 1,52 | | 1500 | | 400 | 30 | | | | | |
| | | | | LSG 3 layers | yes | 8 HSG /' 12 Float /' 12 Float | 1,52 | | 1500 | | 750 | 30 | | | | | |
| | | | | LSG 3 layers | yes | 8 HSG /' 10 HSG /' 10 HSG | 1,52 | | 1250 | | 1250 | 35 | 2 | | A, D | | |
| | | | | LSG 3 layers | yes | 8 HSG /' 12 HSG /' 12 HSG | 1,52 | | 1500 | | 1500 | 35 | | | | | |
| | Point supports | | | LSG 3 layers | yes | 8 HSG /' 15 Float /' 15 Float | 1,52 | | 2000 | | 1400 | 35 | | | | | |
| | | | | LSG 3 layers | yes | | | | | | | 30 | 2 ⁵⁾ , 3, 7 | A, D | | | |
| | | | | Wire glass | no | | | | | | | | | | | | |
| | | | | TSG | no | | | | | | | | | | | | |
| | | | | LSG 2 layers | no | | | | | | | | | | | | |
| | | | | LSG 3 layers | yes | | | | | | | | | | | | |
| | Installed at height > 20 cm | | | Linear support on 2 sides | TSG | no | | | | | | | | | | | |
| | | | | | LSG 2 layers | no | | | | | | | | | | | |
| | | LSG 3 layers | yes | | | | | | | | | 30 | 2, 3, 6, 7 | A, D | | | |
| | | Wire glass | no | | | | | | | | | | | | | | |
| | | Linear support on 4 sides | TSG | | no | | | | | | | | | | | | |
| LSG 2 layers | | | no | | | | | | | | | | | | | | |
| LSG 3 layers | | | yes | 8 HSG /' 10 Float /' 10 Float | 1,52 | | 1500 | | 400 | 30 | | | | | | | |
| LSG 3 layers | | | yes | 8 HSG /' 12 Float /' 12 Float | 1,52 | | 1500 | | 750 | 30 | | | | | | | |
| LSG 3 layers | | | yes | 8 HSG /' 10 HSG /' 10 HSG | 1,52 | | 1250 | | 1250 | 35 | 2 | | A, D | | | | |
| LSG 3 layers | | | yes | 8 HSG /' 12 HSG /' 12 HSG | 1,52 | | 1500 | | 1500 | 35 | | | | | | | |
| Point supports | | LSG 3 layers | yes | 8 HSG /' 15 Float /' 15 Float | 1,52 | | 2000 | | 1400 | 35 | | | | | | | |
| | | LSG 3 layers | yes | | | | | | | 30 | 2, 3, 6, 7 | A, D | | | | | |
| | Wire glass | no | | | | | | | | | | | | | | | |
| | TSG | no | | | | | | | | | | | | | | | |
| | LSG 2 layers | no | | | | | | | | | | | | | | | |
| | LSG 3 layers | yes | | | | | | | | | 2, 3, 6, 7 | A, C, D | | | | | |
| Wire glass | no | | | | | | | | | | | | | | | | |

| | | | | |
|-----------|----------------------|------------------------------------|--------------------------------------|-------------------------|
| Proof by: | 1: No specific proof | 2: Verified static calculations | 3: Installation appr. for spec. case | 4: Pendulum impact test |
| | 5: Heat soak test | 6: Residual load-bearing cap. test | 7: Shock impact resistance test | |

| | | | | |
|--------------------------|--------------------------|------------------------|------------------------|----------------|
| Civil engineering rules: | A: TRLV or DIN 18008-1/2 | B: TRAV or DIN 18008-4 | C: TRPV or DIN 18008-3 | D: DIN 18008-5 |
|--------------------------|--------------------------|------------------------|------------------------|----------------|

Note: where decimal fractions are listed in the table, a comma is used instead of a decimal point to permit the same table contents to be used for all language versions.

- 3) Overhead glazing that has to be capable of supporting human loads to permit cleaning is subject to a special approval procedure.
- 4) The data apply to the smaller distance between supports (support direction).
- 5) If HSG which has not received general statutory construction approval (abZ) is used, an additional Installation Approval for the Specific Case is required.
- 6) If glass type / support type combination systems which have been granted a general statutory construction approval (abZ) are used, the Installation Approval for the Specific Case is not required.

The use of acrylic glass for horizontal glazing is not allowed. However, exceptions may be possible if the trade-fair company has no objections with regard to fire prevention/protection and structural stability.